

Roundabout Model Calibration Issues and a Case Study

TRB National
Roundabout
Conference
Vail, Colorado, USA,
22-25 May 2005



Pictures modified to show driving on the right-hand side of the road



Rahmi Akçelik

Director, Akcelik & Associates Pty Ltd

Adjunct Professor, Monash University

This paper

- ◆ Issues related to **calibration of models** for analyzing roundabout capacity and performance discussed.
- ◆ A **traffic model framework** presented to help with assessment of traffic models in a general framework.
- ◆ While the discussion focuses on **analytical models**, the issues raised are also relevant to **microsimulation models**.
- ◆ Discussion on roundabout models should not concentrate on **capacity alone**, and instead, modeling requirements for estimating **both capacity and performance (v/c ratio, delay, queue length, etc)** should be considered together.
- ◆ Various aspects of **field observations** relevant to the calibration effort are discussed. These include issues related to the **definition and measurement** of capacity, delay and queue length, including the effect of **unequal lane utilization**.
- ◆ **Delay criteria for level of service** definition are also discussed

This paper

- ◆ **Two basic calibration methods** that can be used for gap-acceptance and linear regression methods are described.
- ◆ Further aspects of model calibration discussed include
 - **environment factor**
 - **adjustment for the arrival flow / circulating flow ratio**
 - **lane utilization factor**
 - **heavy vehicle factor**
 - **driver response time**
 - parameters for **operating cost, emissions and fuel consumption**
- ◆ A **case study** is presented to compare capacity estimates from the gap-acceptance and linear-regression methods, including a calibration example

Model calibration

- ◆ **Effective use of models** to analyze intersection capacity, performance and level of service may require **significant calibration effort**.
- ◆ The Highway Capacity Manual defines calibration as "*The process of comparing model parameters with real-world data to ensure that the model realistically represents the traffic environment. The objective is to minimize the discrepancy between model results and measurements or observations.*"
- ◆ The nature of the model in use determines the calibration effort. Therefore, a **good understanding of the basic premises of the model** is an essential step in model calibration.

A Case Study: T-intersection roundabout (based on article by CHARD, UK)

Exclusive approach lanes and single-lane circulating road

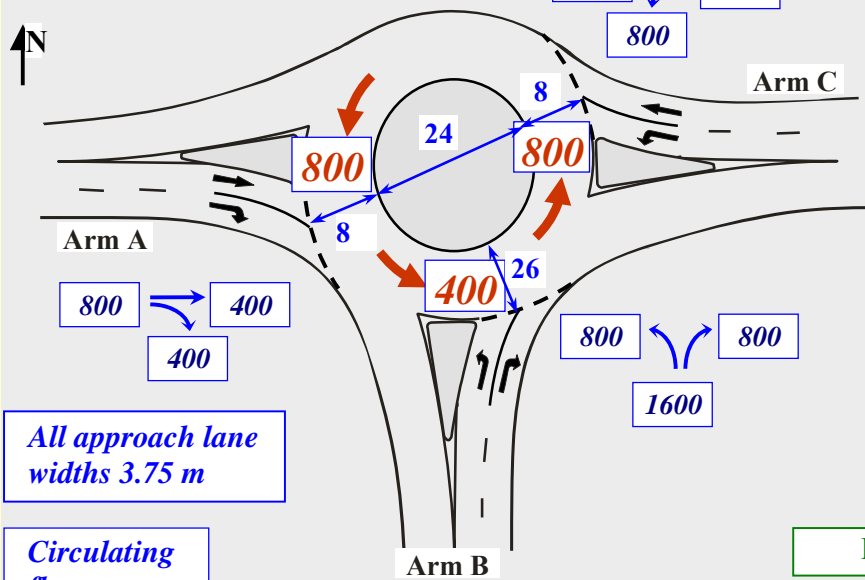

Shared approach lanes and two-lane circulating road

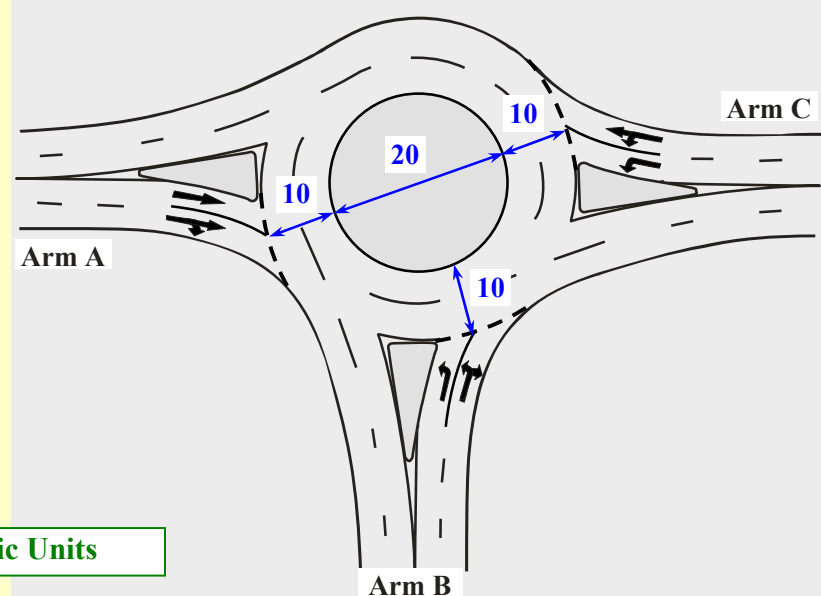

All approach lane widths 3.75 m

Circulating flows are shown with no capacity constraint

Peaking parameters:
 T = 60 min
 T_p = 15 min
 PFF = 1.00
 No Heavy Vehicles

Metric Units

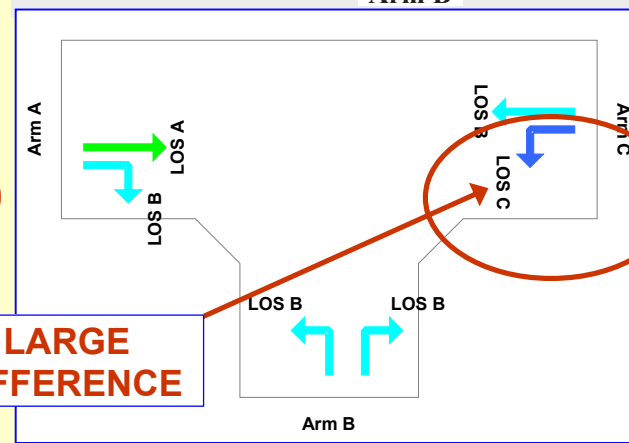
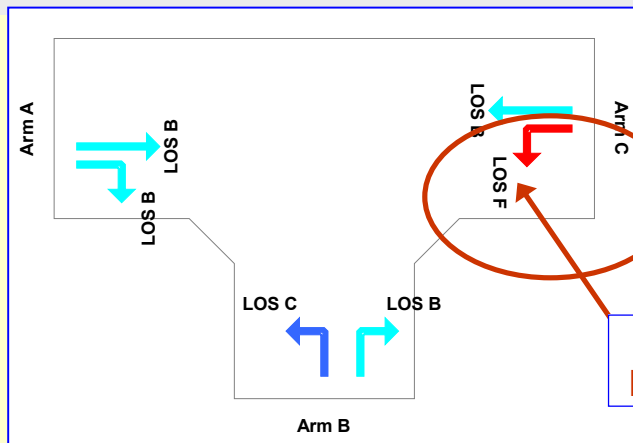

LARGE DIFFERENCE

Capacity results for the T-intersection roundabout

App. ID	Approach Name	Total App. Flow (veh/h)	Circul. Flow (1) (pcu/h)	Critical Lane (2)	Critical Lane Flow (veh/h)	Total App. Capacity (veh/h)	Critical Lane capacity (veh/h)	Degree of saturation (v/c ratio)	Practical Spare Capacity ($x_p = 0.85$)
			aaSIDRA: Single-lane circulating road and exclusive approach lanes						
W	Arm A	800	733	1 (T)	400	1435	629	0.635	34%
S	Arm B	1600	400	1 (L)	800	2167	984	0.813	5%
E	Arm C	1000	800	1 (L)	800	1224	733	1.091	-22%
			aaSIDRA: Two-lane circulating road and shared approach lanes						
W	Arm A	800	800	2 (TR)	431	1507	812	0.531	60%
S	Arm B	1600	400	2 (LR)	841	2050	1078	0.781	9%
E	Arm C	1000	800	2 (LT)	537	1419	762	0.705	21%
			TRL (UK) Linear Regression Model: Same results for both lane arrangements						
W	Arm A	800	800	-	-	1490	-	0.537	58%
S	Arm B	1600	400	-	-	1771	-	0.904	-6%
E	Arm C	1000	800	-	-	1490	-	0.671	27%

- (1) Circulating flows for two-lane circulating road are without any capacity constraint since all approach lanes are estimated to be undersaturated (both models).
- (2) aaSIDRA approach degrees of saturation represent the critical lane degrees of saturation (L: Left, T: Through, R: Right). The TRL capacity model combines exclusive and shared lanes to obtain an average approach degree of saturation.

Comparisons

- ◆ **aaSIDRA** estimates **differ significantly** for the single-lane and two-lane circulating road cases
- ◆ The UK (TRL) model estimates for the two cases are **identical**.
- ◆ Assumptions of the "**approach**" method used in the UK (TRL) model are close to the case of *two-lane circulating road with shared approach lanes*, and therefore in close agreement with the aaSIDRA method.
- ◆ On the other hand, a **large discrepancy** is found between the two models in the case of *single-lane circulating road with exclusive lanes*.

Comparisons

- ◆ aaSIDRA estimates of **delay, operating cost, fuel consumption and CO₂ emission** comparing the case of **single-lane circulating road with exclusive lanes** vs the case of **two-lane circulating road with shared lanes** showed that, considering **annual** values of **one hour of traffic operation only**, the difference between the two cases amounted to approximately:
 - **9,000** person-hours of delay
 - **US\$72,000** in operating cost
 - **14,000 L** of fuel consumption
 - **34,000 kg** of CO₂ emission per year.

Lane Utilization

- ◆ Different methods have been used to measure and model capacities in terms of *level of aggregation*:
 - (i) *lane-by-lane* analysis as in aaSIDRA
 - (ii) analysis by *lane groups* as in the HCM, and
 - (iii) analysis by *total approach flows*, i.e. all movements in all approach lanes aggregated, as in the TRL method for roundabout capacity analysis
- ◆ A simple **sum of lane capacity values** calculated as the lane group or approach capacity is misleading in the case of lane **underutilization** since such an aggregate capacity value does not reflect the **critical lane volume - capacity ratio**, and therefore may **underestimate** delays and queue lengths significantly.
- ◆ It is important to carry out **functional design** to ensure balanced use of approach and circulating road lanes before detailed design of a roundabout (including use of bypass lanes, i.e. slip lanes and continuous lanes).

An example of lane capacity and approach capacity values with equal and unequal lane volumes (equal lane capacity values assumed for simplicity)

Case 1: Equal lane volumes

	Lane 1	Lane 2	Approach
Volume =	600	600	1200
Capacity =	1000	1000	2000
V/C Ratio =	0.60	0.60	0.60

Simple sum of lane capacity values is acceptable in this case.

Case 2: Unequal lane volumes

	Lane 1	Lane 2	Approach
Volume =	400	800	1200
Capacity =	1000	1000	1500
V/C Ratio =	0.40	0.80	0.80

LARGE DIFFERENCE

The approach V/C ratio is determined as the *critical lane* V/C ratio. The corresponding approach capacity is $1000 \times (1 + 0.40 / 0.80) = 1500 \text{ veh/h}$ to give approach V/C ratio of $1200 / 1500 = 0.80$.

Unequal lane use may be due to:

- ◆ **exclusive lanes** as determined by lane marking and signing,
- ◆ **path overlap** on the circulating road due to poor roundabout design, and **lack of circulating lane markings**,
- ◆ a lane that discontinues at the downstream side due to a decreased number of lanes or parked vehicles (**downstream short lane**),
- ◆ a lane with a large proportion of traffic turning left or right at a downstream location (**destination effect**),
- ◆ some **interference at the downstream side**, e.g. vehicles merging from a slip lane with no clear give-way (yield) lane markings,
- ◆ a large number of **heavy commercial vehicles or buses** (moving or stopping) in the lane,
- ◆ **turning vehicles** in the lane subject to heavy **pedestrian conflict at the exit**,
- ◆ heavy interference by **parking maneuvers** (parking adjacent to the lane),
or
- ◆ an **approach short lane** (e.g. a turn bay, or a limited queuing space due to parking upstream).

Calibration parameters

- ◆ The model input parameters representing **driver behavior, vehicle characteristics, the intersection geometry and control** need to be identified for the purpose of calibration.
- ◆ For roundabouts and other unsignalised intersections, **gap-acceptance parameters** (especially follow-up headway and critical gap) are the key parameters representing **driver behavior**.
- ◆ The overall **roundabout geometry** (configuration of approach roads, number of approach and circulating road lanes, allocation of lanes to movements) affects the capacity and performance directly.
- ◆ The **gap-acceptance parameters** as well as the approach and circulating road **lane use** are affected by the **roundabout geometry** as well as the overall demand **flow levels and patterns**.

Calibration methods

- ◆ **Modify the follow-up headway and critical gap values** so that estimates of capacity, delay or queue length values match the observed values, as provided with the aaSIDRA method
- ◆ **Modify the intercept value of the linear capacity - circulating flow equation**, as provided with the UK (TRL) linear regression method

Calibration of gap-acceptance parameters to match observed capacity

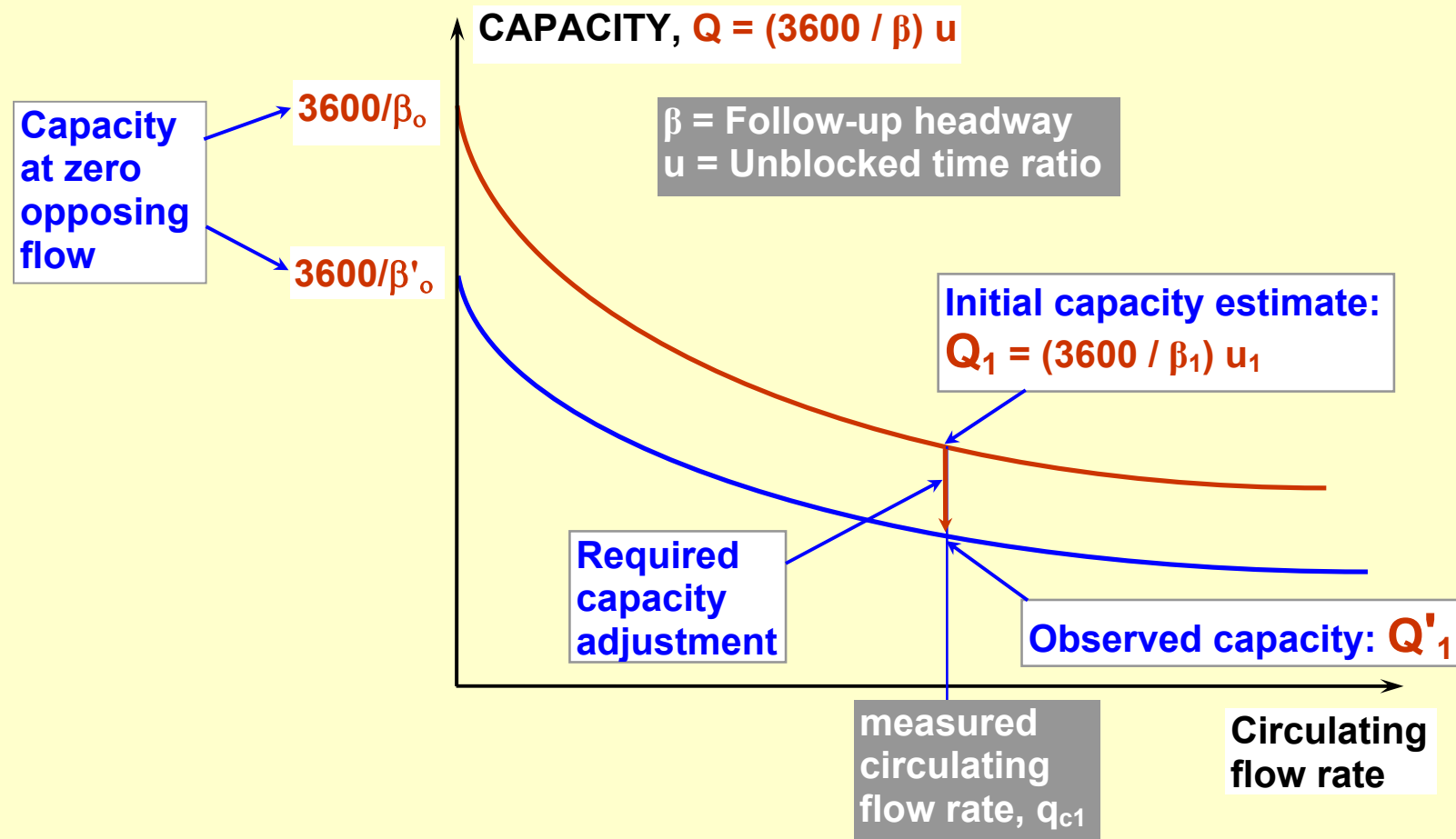

Adjustment of the intercept of linear regression equation to match observed capacity

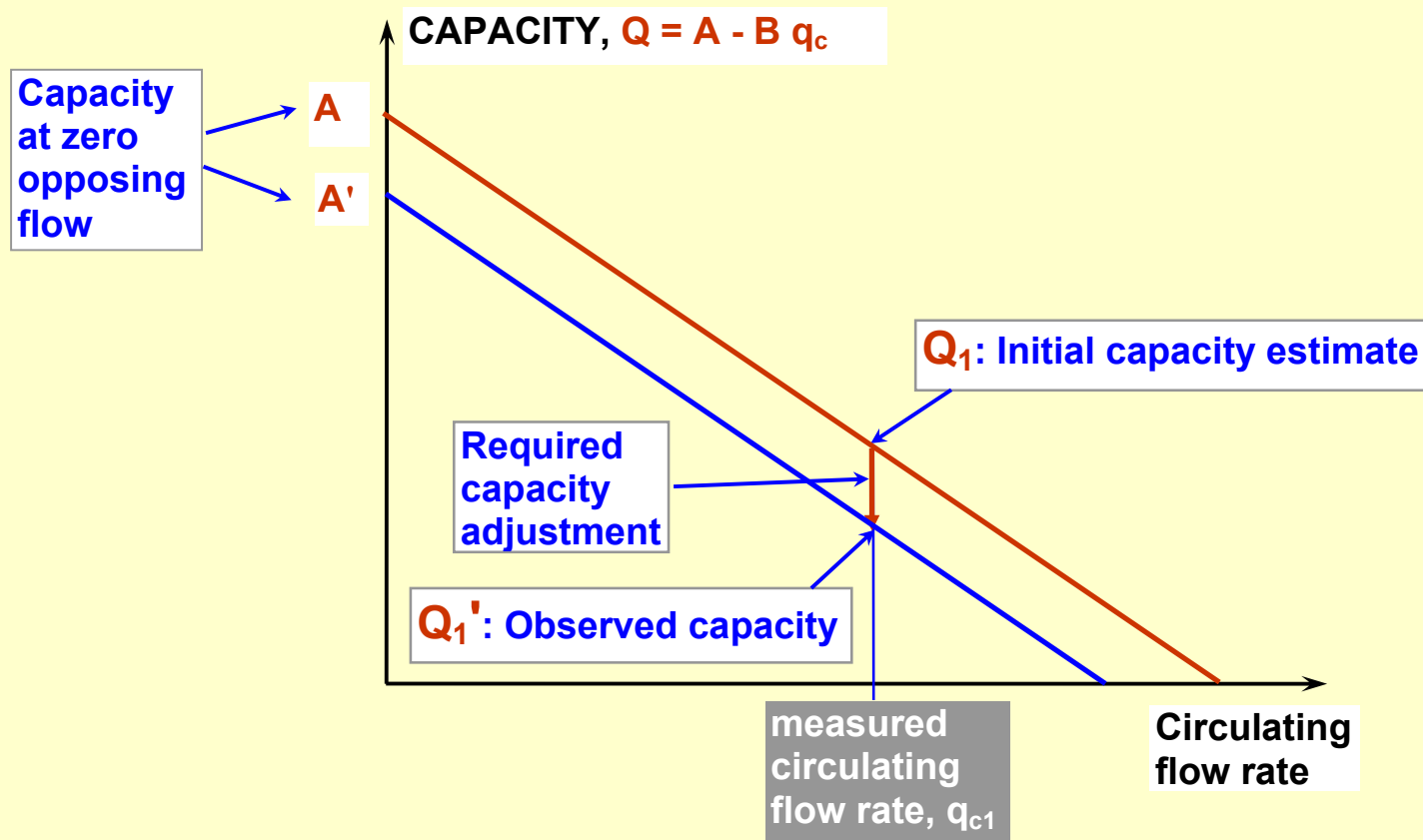

Model calibration process: aaSIDRA and other gap-acceptance methods

Observed parameters	Gap-acceptance parameters	Capacity	Delay or Queue Length
Gap-acceptance parameters	Specify observed gap-acceptance parameters.	Capacity estimate is modified by observed gap-acceptance parameters.	Affected by modified capacity estimate (indirect effect), and observed gap-acceptance parameters (direct effect).
Capacity	Specify modified gap-acceptance parameters to match observed capacity.	Observed capacity is achieved.	Affected by observed capacity (indirect effect), and modified gap-acceptance parameters (direct effect).
Delay or queue length	Specify modified gap-acceptance parameters to match observed delay or queue length.	Capacity estimate is affected via modified gap-acceptance parameters.	Observed delay or queue length is achieved using modified gap-acceptance parameters (direct effect) and the resulting modified capacity estimate (indirect effect).

Model calibration process: UK and other linear regression methods

Observed parameters	Gap-acceptance parameters	Capacity	Delay or Queue Length
Capacity	Not applicable	Specify modified intercept to match observed capacity.	Affected by observed capacity (indirect effect).
Delay or queue length	Not applicable	Specify modified intercept to match observed delay or queue length. Capacity estimate is affected via modified intercept.	Observed delay or queue length is achieved using modified capacity estimate (indirect effect).

Environment Factor

Higher capacity: good visibility, more aggressive and alert driver attitudes (smaller response times), negligible pedestrian volumes, insignificant parking and heavy vehicle activity (goods vehicles, buses, trams stopping on approach roads).

Lower capacity: low visibility, relaxed driver attitudes (slower response times), high pedestrian volumes, significant parking and heavy vehicle activity (goods vehicles, buses, trams stopping on approach roads).

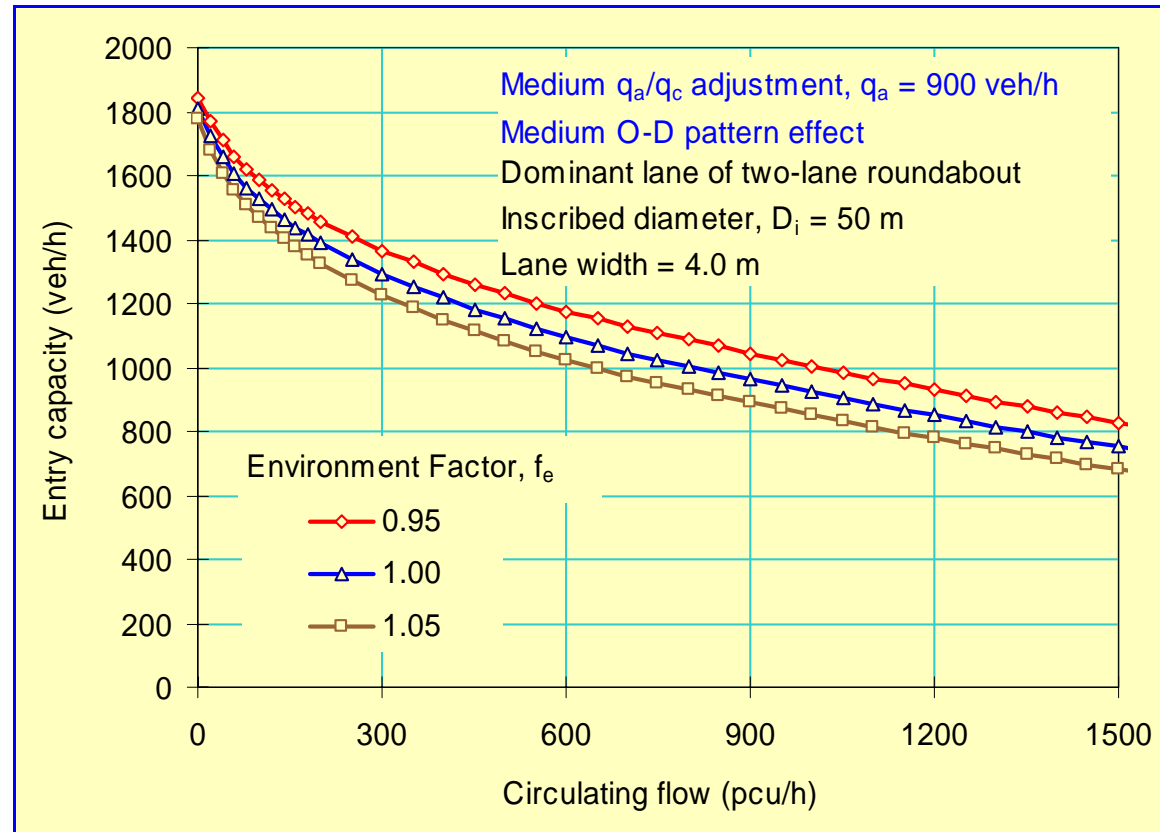

Adjustment Level for Arrival Flow / Circulation Flow Ratio

In order to avoid underestimation of capacities at low circulating flows, aaSIDRA decreases the dominant lane follow-up headway as a function of the ratio of arrival (entry lane) flow to circulating flow.

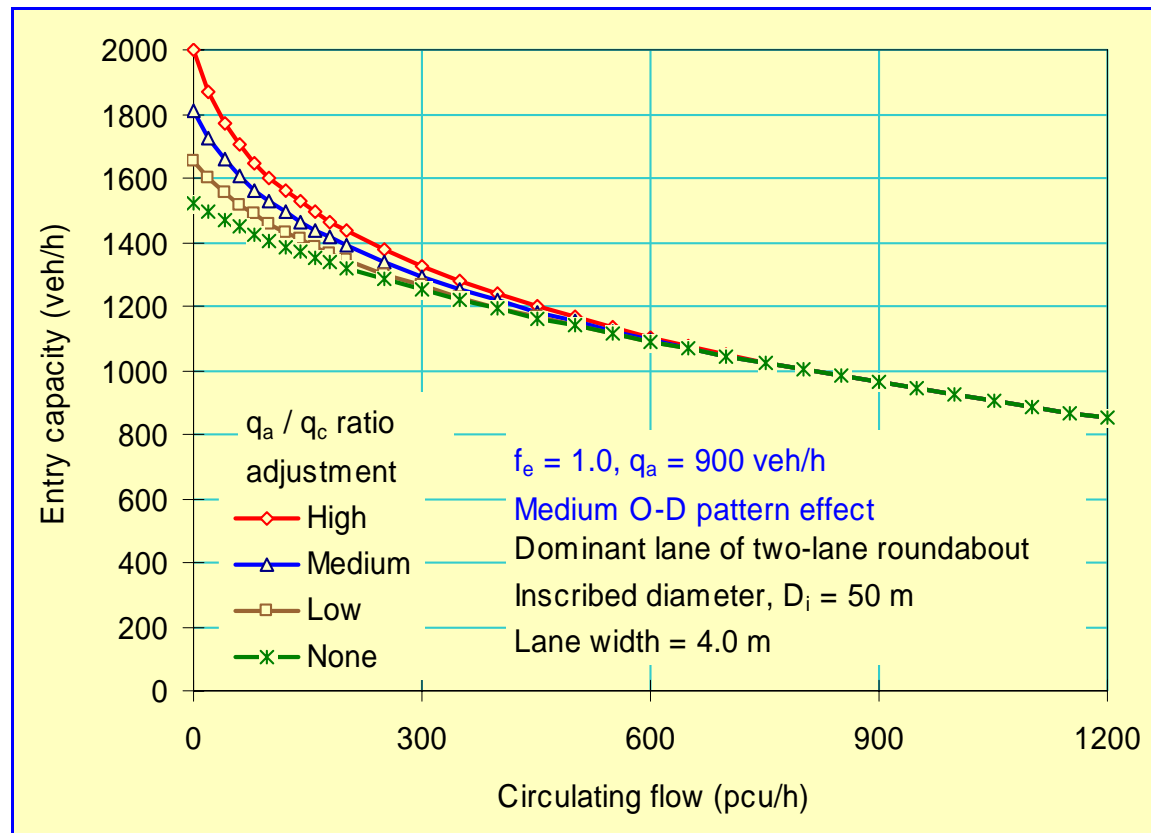

Excel application for model comparison - HCM single-lane roundabout example, WB approach:

inscribed diameter = 36 m (118 ft), entry lane width = 4.0 m (13 ft), approach half width = 3.5 m (11.5 ft), turn radius = 26 m (84 ft), flare length = 20 m (66 ft), entry angle = 30°

aaSIDRA model with **default parameters**:
Environment Factor = 1.0, **Medium** entry flow adjustment, Medium O-D pattern effect

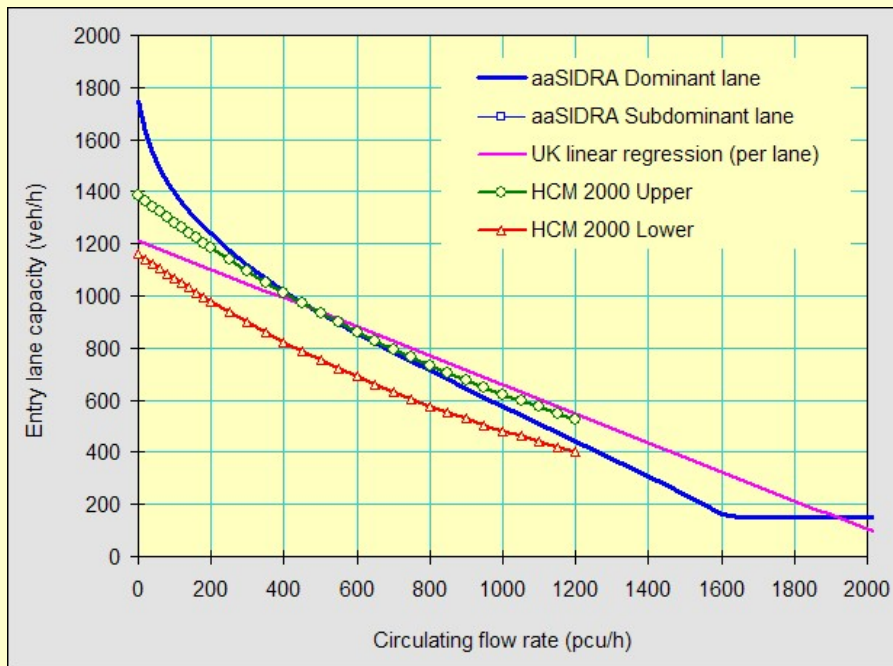

No subdominant lane

aaSIDRA model **calibrated to match the HCM lower capacity model**:
Environment Factor = 1.15, **Low** entry flow adjustment, Medium O-D pattern effect

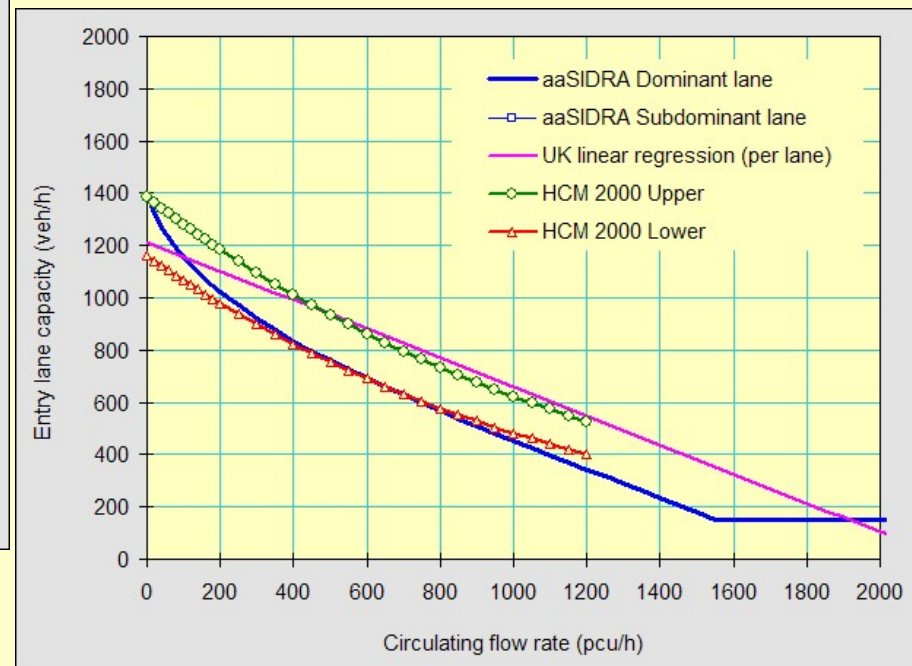

Model Framework

		ROAD GEOMETRY ELEMENTS		
TRAFFIC ELEMENTS		APPROACHES (all lanes aggregated)	LANE GROUPS (or "links")	LANES (or lane segments)
	Individual vehicles			Micro-simulation
	Platoons	Macro-simulation		Meso-simulation
	Drive cycles			Micro-analytical
	Traffic flows	Macro-analytical	Meso-analytical	
	Speed-flow models	Macro-analytical		

About models

- ◆ a **simulation** model can be microscopic, macroscopic or mesoscopic
- ◆ an **analytical** model can be microscopic, macroscopic or mesoscopic, and
- ◆ a **simulation** model can be deterministic or stochastic
- ◆ contrasting models as "**empirical vs theoretical**" (as frequently done in the literature in relation to roundabout capacity models) represents **a simplistic view** since most models have basis in traffic behavior theory and are empirical at the same time.

Roundabout capacity models (analytical)

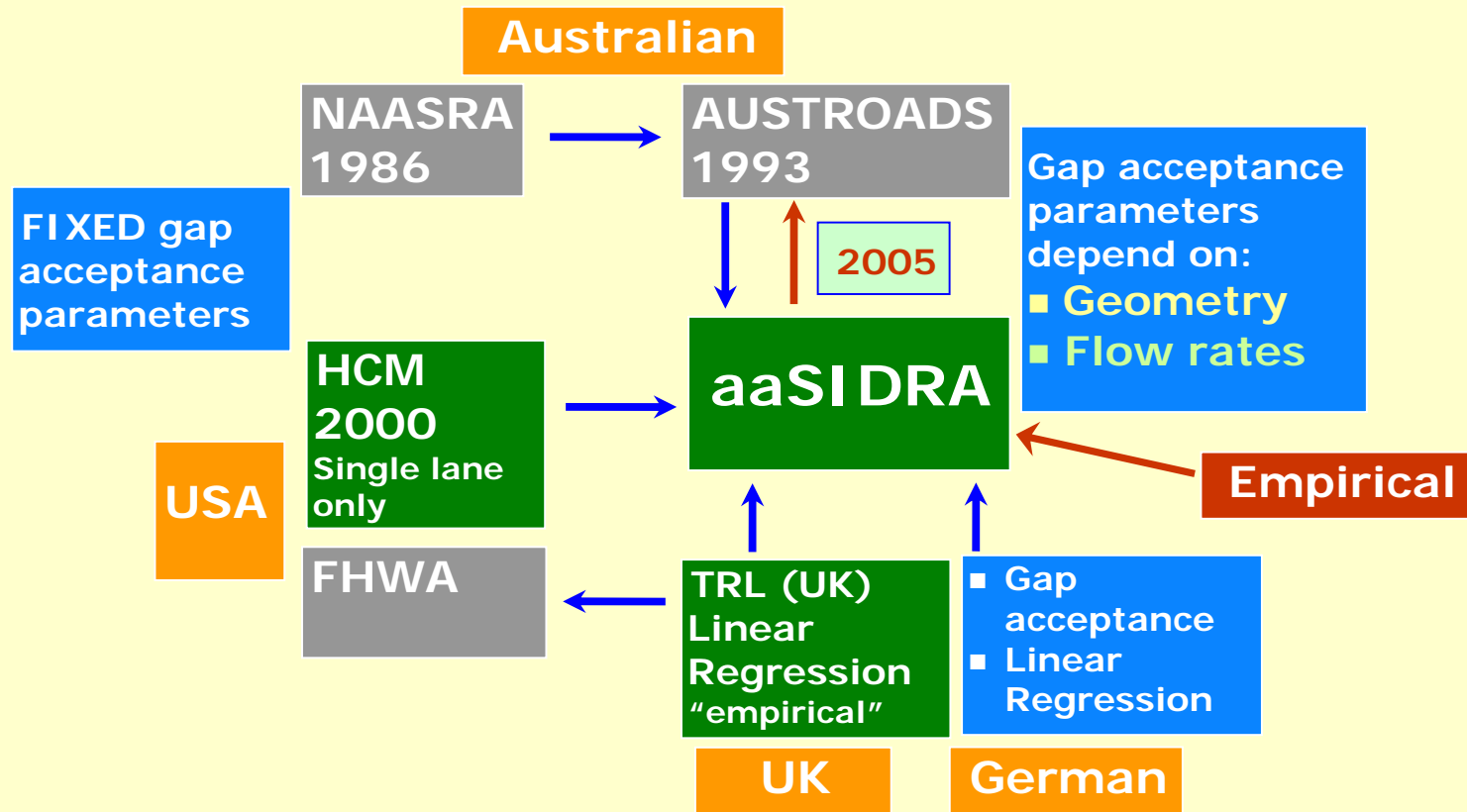

Roundabout capacity and performance models

Both **roundabout geometry** and **driver behavior** (driver - vehicle characteristics) are needed.

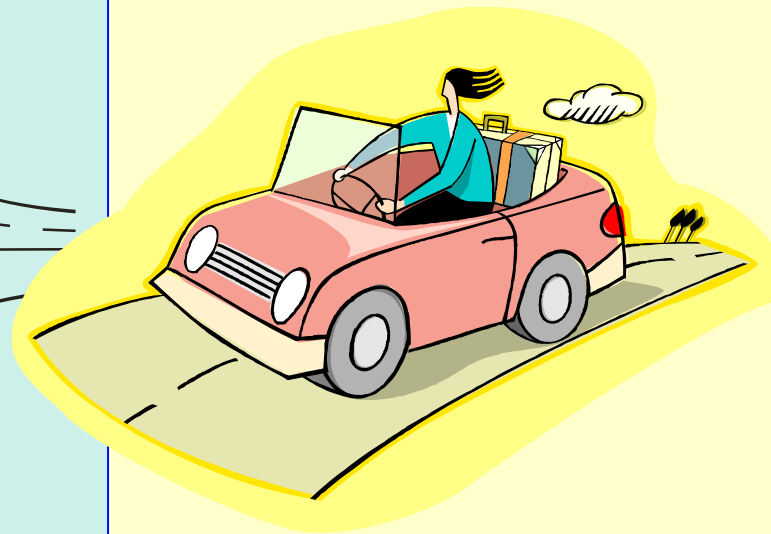
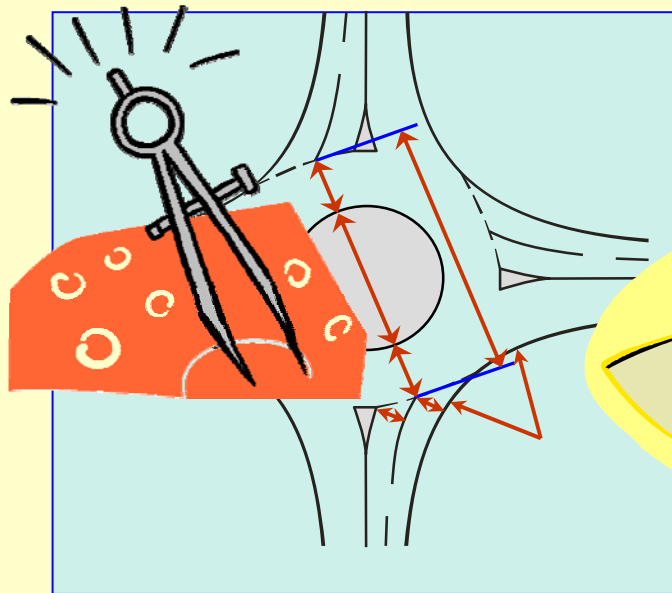

Roundabout capacity and performance

aaSIDRA used in the analyses reported in this paper employs an *empirical gap-acceptance method* to model roundabout capacity and performance. The model allows for the effects of *both roundabout geometry and driver behaviour*, and it incorporates effects of *priority reversal* (low critical gaps at high circulating flows), *priority emphasis* (unbalanced O-D patterns), and *unequal lane use* (both approach and circulating lanes).

CAPACITY can be measured as a *service rate* for each traffic *lane* in *undersaturated conditions* (v/c ratios less than 1) according to the HCM definition of capacity to represent "*prevailing conditions*". This is in contrast with measuring *approach* capacity in *oversaturated conditions*.

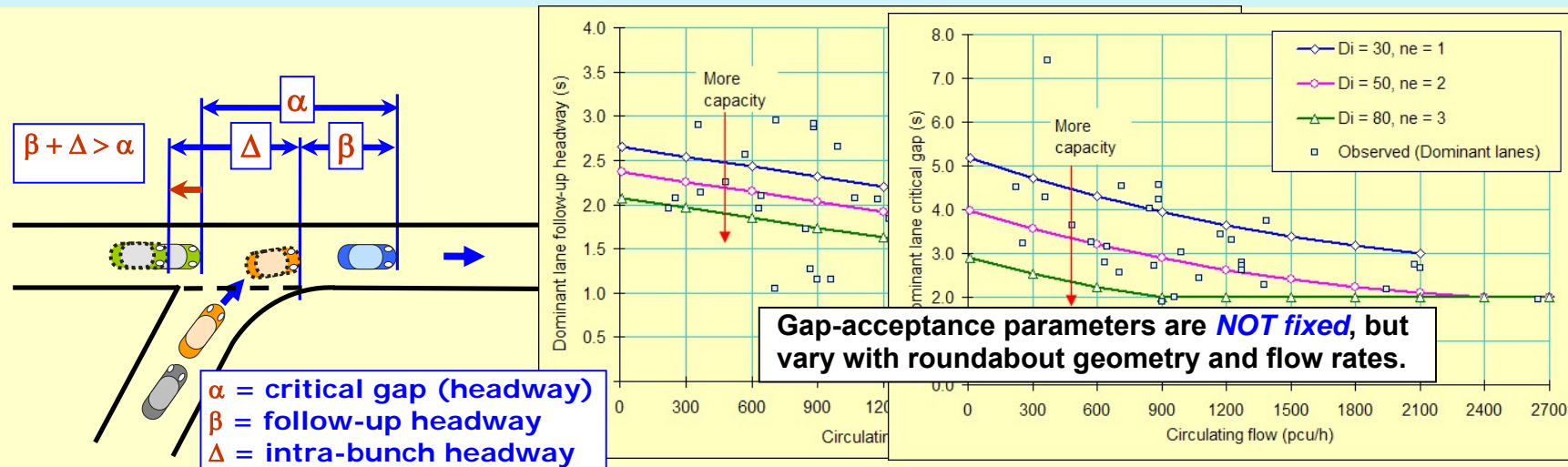

Australian roundabout survey data used for calibrating the Australian gap-acceptance based capacity and performance models

	Total entry width (ft)	No. of entry lanes	Average entry lane width (ft)	Circul. width (ft)	Inscribed Diameter (ft)	Entry radius (ft)	Conflict angle (°)
Minimum	12	1	10	21	52	13	0
Maximum	41	3	18	39	722	∞	80
Average	27	2	13	31	183	128	29
15th percentile	21	2	11	26	93	33	0
85th percentile	34	3	15	39	230	131	50
Count	55	55	55	55	55	55	55
	Follow-up Headway (s)	Critical Gap (s)	Crit. Gap / Fol. Hw Ratio	Circul. flow (veh/h)	Total entry flow (veh/h)	Dominant lane flow (veh/h)	Subdom. lane flow (veh/h)
Minimum	0.80	1.90	1.09	225	369	274	73
Maximum	3.55	7.40	3.46	2648	3342	2131	1211
Average	2.04	3.45	1.75	1066	1284	796	501
15th percentile	1.32	2.53	1.26	446	690	467	224
85th percentile	2.65	4.51	2.31	1903	1794	1002	732
Count	55	55	55	55	55	55	55

Data from roundabout capacity surveys at UK roundabouts (indicating regression model bias)

At-grade roundabout in Wincheap, Canterbury, UK

Regression line

Small number of data points at low and high circulating flows

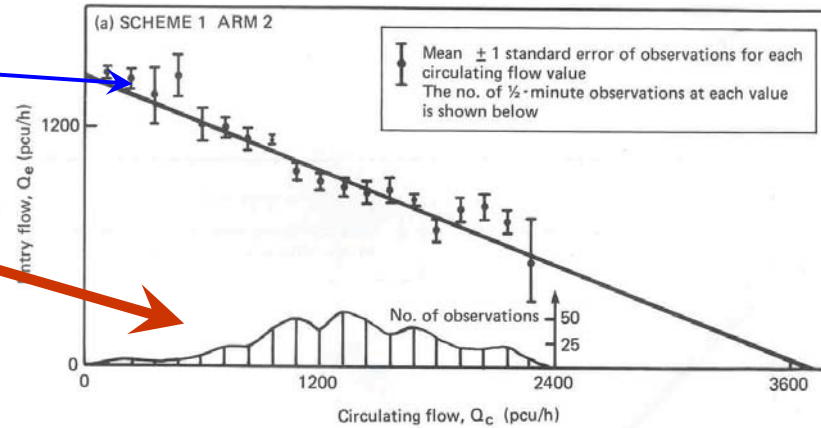

Grade-separated roundabout in Bradford, UK

Regression lines

Small number of data points at low and high circulating flows

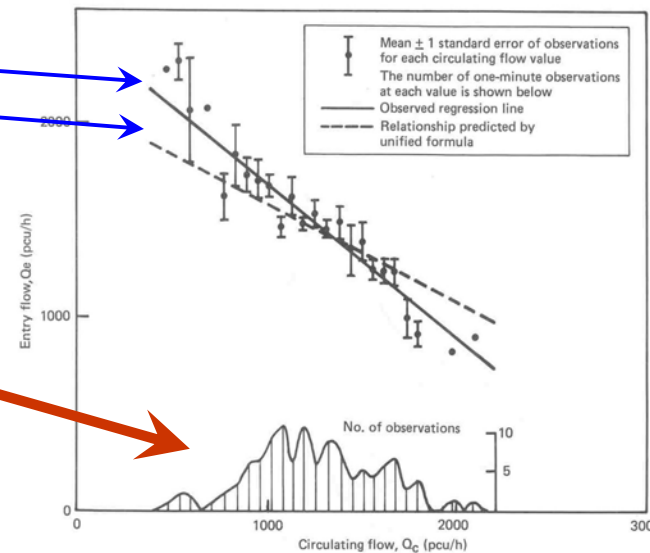

Examples of 'Conventional' and 'Offside Priority' roundabout designs used in capacity measurements for TRL (UK) linear regression model

'Conventional' Design

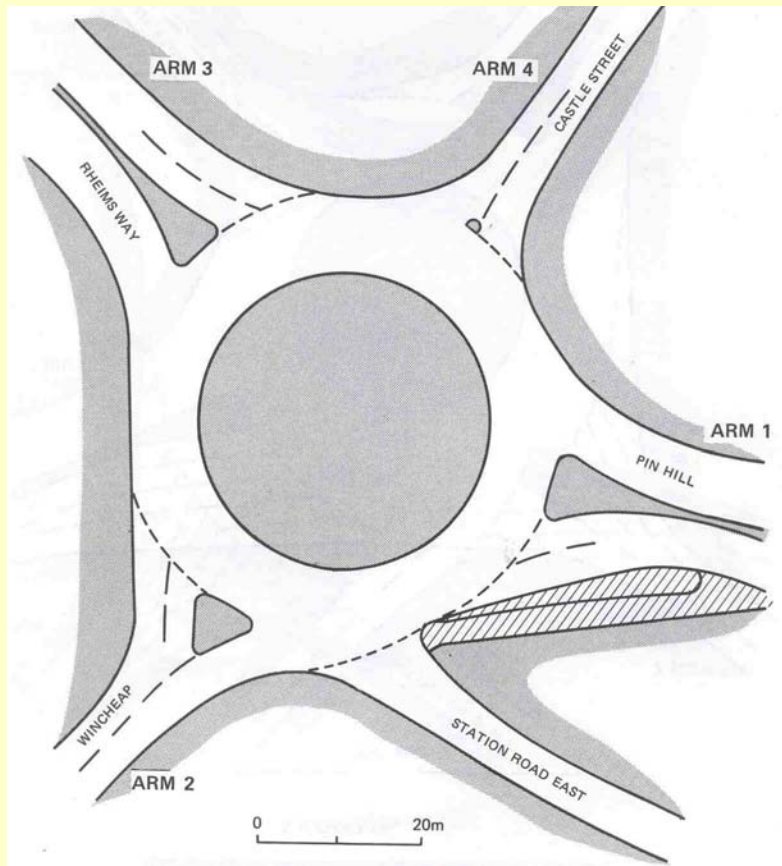

'Offside Priority' Design

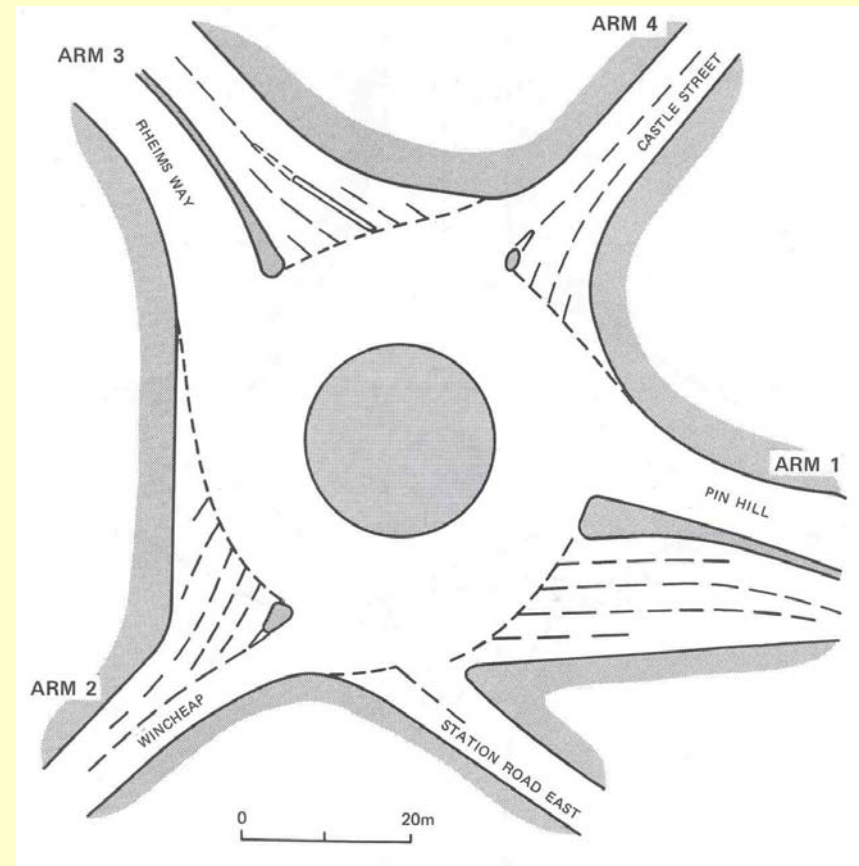

These old or experimental roundabout designs have not been used in Australia or USA

CAPACITY

- ◆ Capacity is the **maximum sustainable flow rate** that can be achieved under **prevailing** road, traffic and control conditions.
- ◆ Capacity is **not a constant value**.
- ◆ Capacity represents the **service rate** (queue clearance rate) in the performance functions, and therefore is **relevant to both undersaturated and oversaturated** conditions.
- ◆ Not to be confused with the **maximum volume that the intersection can handle**.
- ◆ **Two distinct methods of measuring capacity:**
 - (i) measuring **departure (saturation) flow rates** during saturated (queued) portions of **unblocked periods of gap-acceptance cycles** and the associated proportion of time available for queue discharge, and
 - (ii) measuring departure flow rates (volume counts) at the stop or give-way (yield) line **under continuous queuing (saturated) conditions**.

Delay definition and measurement

Survey methods

- ◆ path-trace (instrumented car)
- ◆ queue-sampling (queue count)

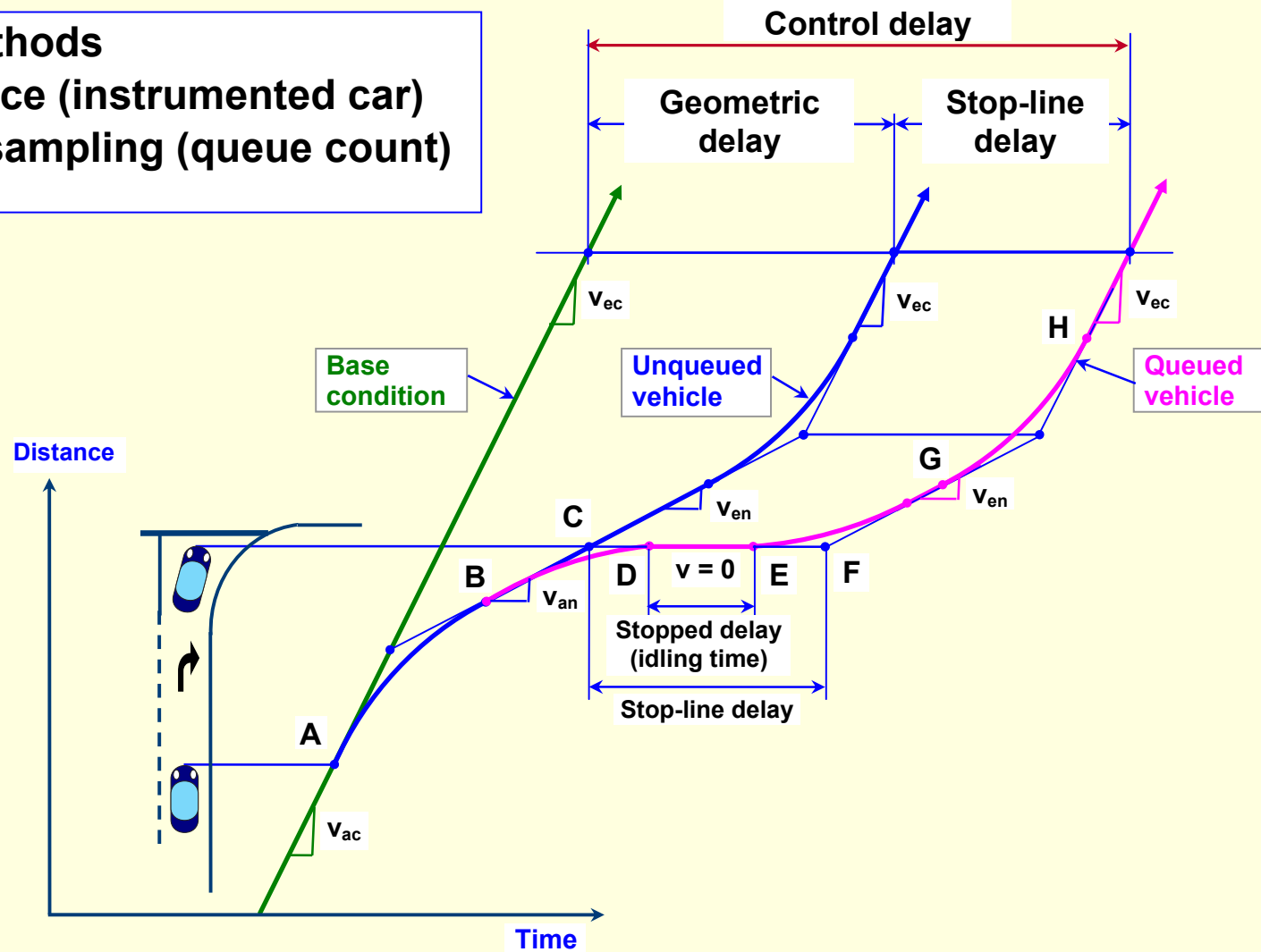

Delays experienced by vehicles in oversaturated conditions

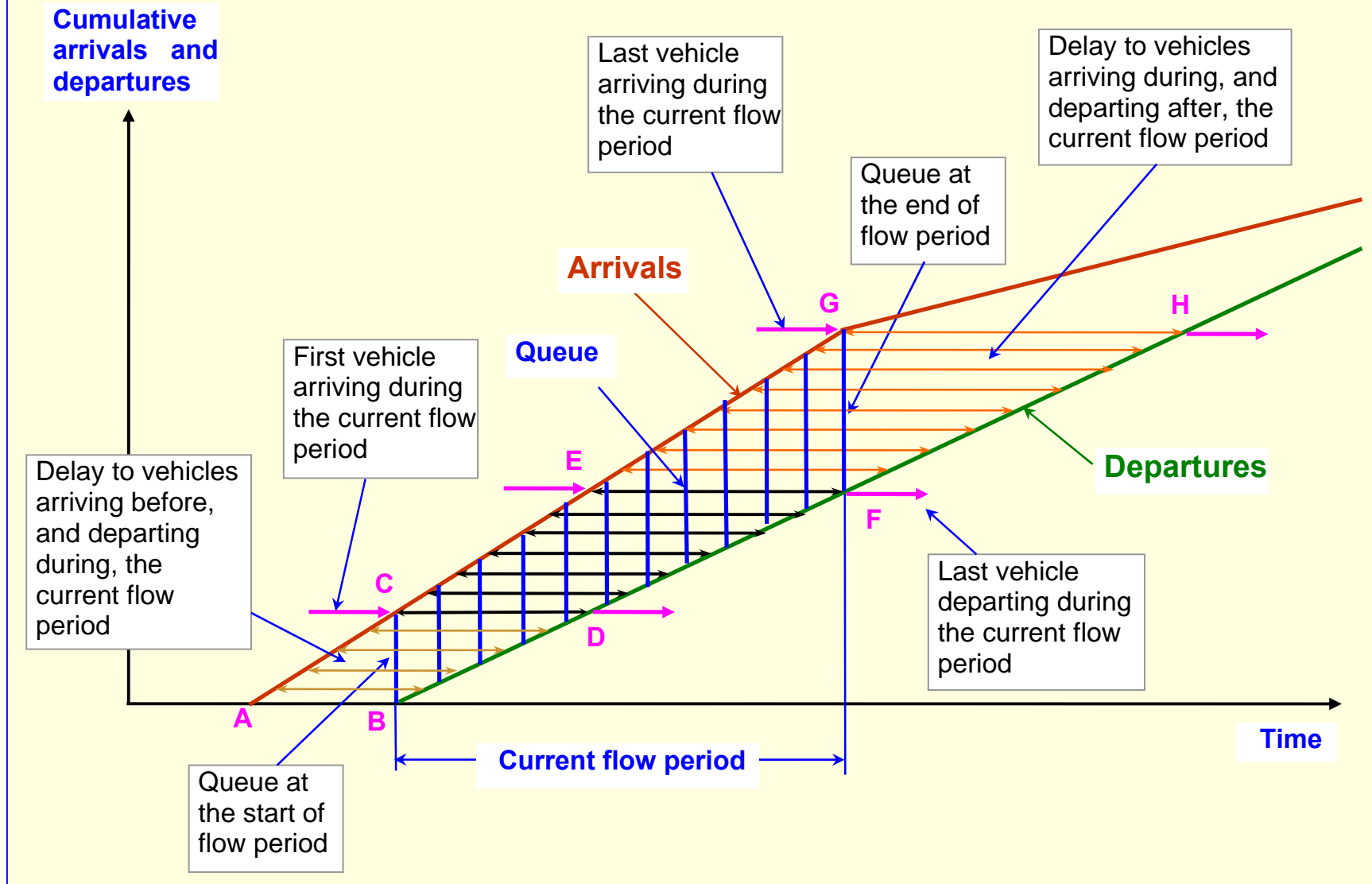

Queue definition and measurement

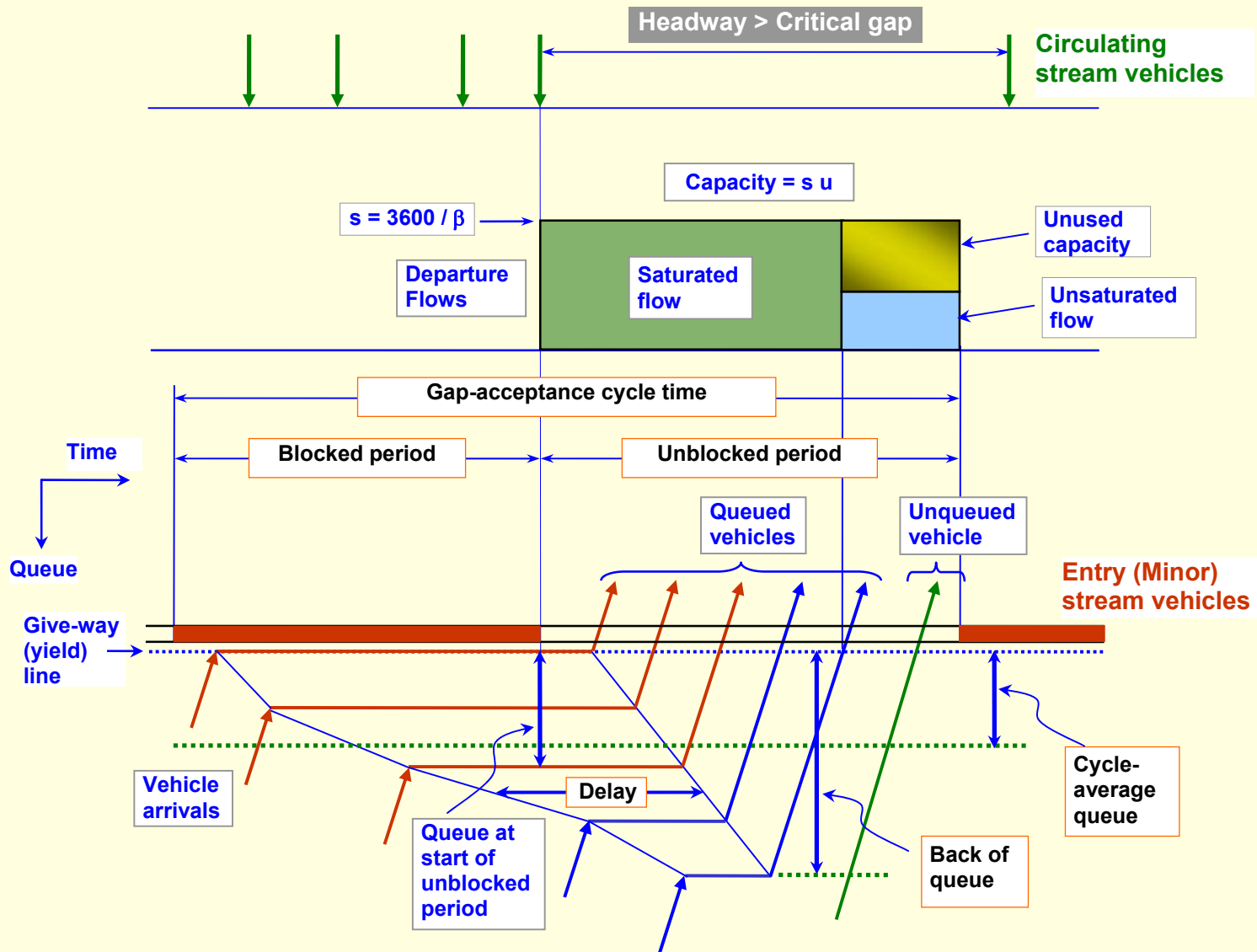

Conclusion

- ◆ Calibration effort usually focuses on making the **best use of an available model** in matching the estimates of capacity, delay, queue length, and other statistics produced by the model with values **observed in the field**.
- ◆ While such an effort can be successful in specific cases, such success **does not guarantee the model validity** in a general sense. This applies to all models, analytical and simulation.
- ◆ Discussion on the nature of models from the perspective of a **general modeling framework** is recommended in order to assess the capabilities of alternative models.
- ◆ Such discussion should **not be limited to capacity or individual performance measures**, but a more general evaluation of model capabilities should be undertaken.

Disclaimer

The author is the developer of the **aaSIDRA model**, and comments presented in this paper regarding other models should be read with this in mind.

The comments about the **TRL (UK) linear regression model** are relevant to the original published model and are valid for software packages using that model only to the extent that the original model is used without modification to address the issues raised in this paper.

End of presentation

NO MODEL IS PERFECT

**Question model assumptions and
data accuracy
(ALL MODELS!)**

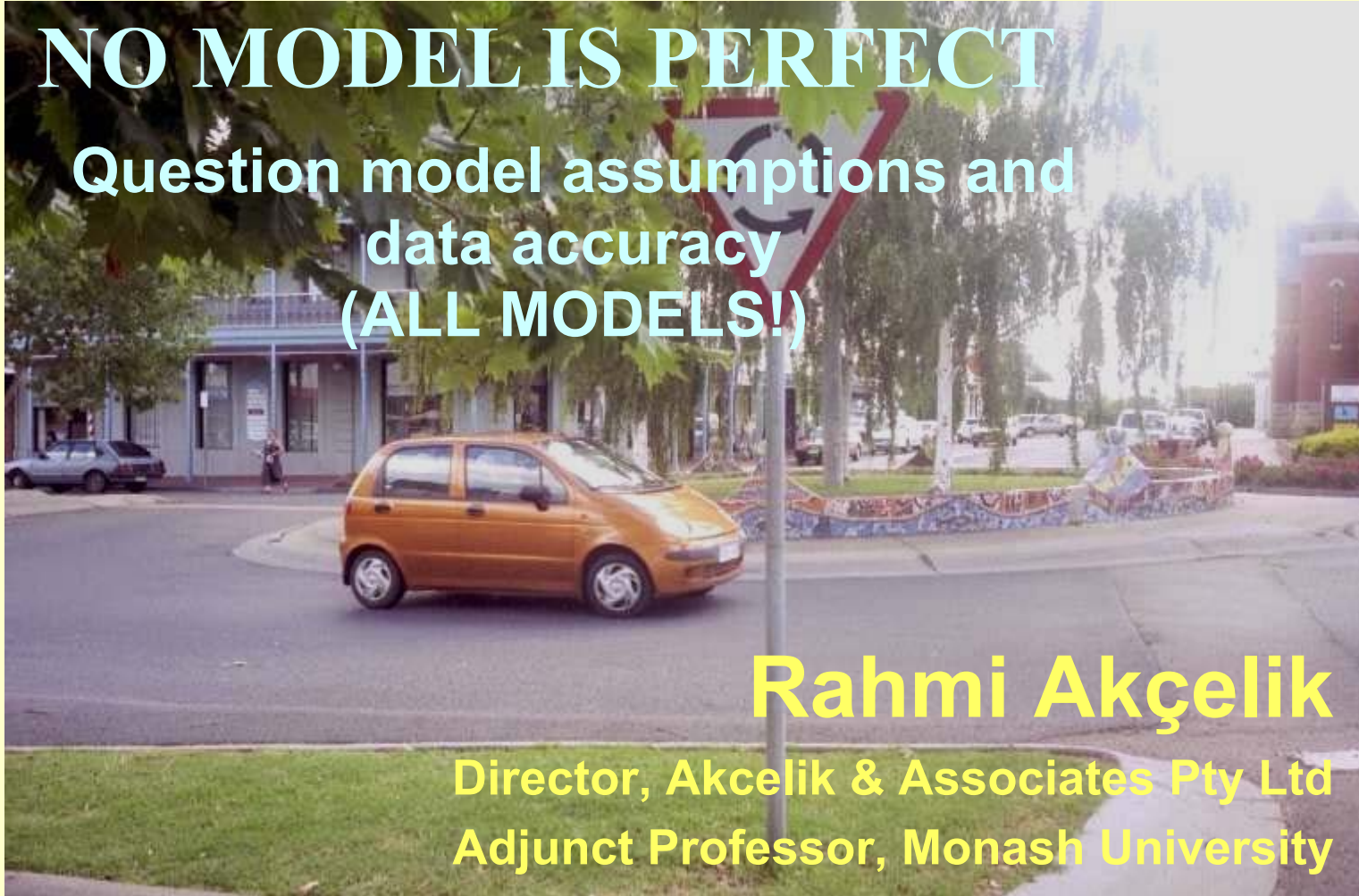

Rahmi Akçelik

**Director, Akcelik & Associates Pty Ltd
Adjunct Professor, Monash University**